



Power. Precision. Performance.

**THE  
FOCUS  
IS THE  
FINISH.**

**BURS  
ROUTERS  
DIE TRIMMERS**

**Time-tested tools to cut  
time on the job.**





**Great finishes begin with great tools.**

And great tools like these begin with IMCO's advanced technology. We put decades of cutting tool know-how into all IMCO burs and routers. Which is why you get so much more out of them.



**Power. Precision. Performance.**

# CONTENTS:

## 4 Features: IMCO Burs

IMCO carbide burs last many times longer than their HSS counterparts at a comparable cost.

6  **SA Cylindrical-Shape Burs**  
Single Cut / Double Cut / Aluma Cut Flute Styles

7  **SB End Cut Cylindrical-Shape Burs**  
Single Cut / Double Cut / Aluma Cut Flute Styles

8  **SC Radius End Cylindrical-Shape Burs**  
Single Cut / Double Cut / Aluma Cut Flute Styles

9  **SD Ball-Shape Burs**  
Single Cut / Double Cut / Aluma Cut Flute Styles

10  **SE Oval-Shape Burs**  
Single Cut / Double Cut / Aluma Cut Flute Styles

11  **SF Radius End Tree-Shape Burs**  
Single Cut / Double Cut / Aluma Cut Flute Styles

12  **SG Pointed End Tree-Shape Burs**  
Single Cut / Double Cut Flute Styles

13  **SH Flame-Shape Burs**  
Single Cut / Double Cut Flute Styles

14  **SL Taper-Shape Burs**  
Single Cut / Double Cut / Aluma Cut Flute Styles

15  **SM Cone-Shape Burs**  
Single Cut / Double Cut Flute Styles

16  **SJ 60° Cone-Shape Countersink Burs**  
Single Cut / Double Cut Flute Styles

17  **SK 90° Cone-Shape Countersink Burs**  
Single Cut / Double Cut Flute Styles

18  **SN Inverted Cone-Shape Burs**  
Single Cut / Double Cut Flute Styles

20  **Bur Sets**  
Double Cut and Standard Cut sets available

21  **PDT10 Die Trimmers**  
Double Cut for die repair.

22  **FR10 Routers**  
Diamond patterned flutes for routing fiberglass and graphite composite laminates.

# BURS

## A half-century of know-how from our hands to yours.

Any machinist worth his salt will tell you: there's no substitute for the deep knowledge that comes with decades of making tools that do the job right.

Sure, we use the same advanced technologies and CNC precision to make all our cutting tools. But it's that know-how that makes IMCO burs work harder and *many times longer* than burs made by anyone else.

Some call it craftsmanship. We call it knowing what we're doing.

## Bur Product Features

Sectional fluting enables burs to cut on the radius as well as the body of the tool.

Three bur styles – double cut, standard cut and aluma cut – in a full range of shapes and sizes. Special grinds – fine cut, coarse cut and diamond cut – available upon request.



## Bur starting parameters

Bur Diameter		Starting RPMs	
Inch	Metric	Common Materials	Stainless Steel
1/16	1,5	70,000	105,000
1/8	3	50,000	75,000
3/16	4,7	40,000	60,000
1/4	6,3	30,000	45,000
5/16	8	27,000	41,500
3/8	9,5	22,000	33,000
7/16	11	20,000	30,000
1/2	12,7	18,000	27,500
5/8	16	16,000	24,000
3/4	19	14,000	21,000
1	25,4	12,000	18,000

Long shank burs should be run at lower RPM

CNC precision-ground flutes for repeatability, chatter-free operation and longer life.

100% inspection of high-temperature brazing to ensure structural integrity.

Shanks are made from high-quality alloy steel hardened to HRC 45-49 to ensure maximum strength and durability.

Long and extra-long shanks available standard for many burs with a wide array of shank modifications available for all styles.

# BURS

## Bur Cut Styles

Select the cut style for the finish you need from the choices below. Precision flute grinding ensures chatterless operations and a long tool life.



### Double cut

Right- and left-hand flutes combine to produce a chisel-type cutting edge. You get faster penetration and stock removal, and better control and less operator fatigue due to reduced pull.



### Standard cut

This style has only right-hand spiral flutes, producing good stock removal and excellent surface finishes. Use this cut for general deburring in cast iron, steel, copper alloys, brass alloys and other ferrous materials.



### Aluma Cut

Wide flutes make the aluma cut ideal for easy chip clearance. That means fast stock removal in aluminum, brass, zinc alloys, most plastics and soft, non-ferrous materials. IMCO's advanced relief design gives it greater strength, so it lasts a lot longer.

IMCO burs are for general purpose deburring operations in these materials:

		Standard	Double	Aluma
<b>P</b>	Carbon & tool steels ≤ 48 HRC	●	●●	
<b>H</b>	Carbon & tool steels > 48 HRC	●	●●	
<b>M</b>	Stainless steels	●	●●	
<b>S</b>	Super alloys, Inconel®, titanium	●	●●	
<b>K</b>	Cast irons	●	●●	
<b>A</b>	Aluminum & non-ferrous			●●

● Suitable ●● Recommended

## Special Bur Cuts

Other styles of cuts are available upon request:

### Fine Cut Style

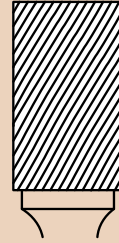

Recommended when a better surface finish is a priority. Use in materials with HRC 55-60.

### Coarse Cut Style



Offers rapid stock removal in copper, brass, plastics, rubber and other easily machined materials.

### Diamond Cut Style

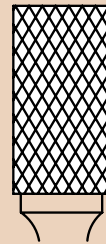

For use on heat-treated and tough alloy steels. Balanced cutting action provides better operator control. Stock removal is increased; finish is sacrificed. Especially recommended for welding applications.

## SPECIAL GRINDS

Need a custom bur that's "outside the box?" We can do that. That kind of versatility is one more BIG benefit of serious tool-making know-how. Visit [www.imcousa.com](http://www.imcousa.com) and click on Contact Us.

# SA

## SA Cylindrical-Shape Burs

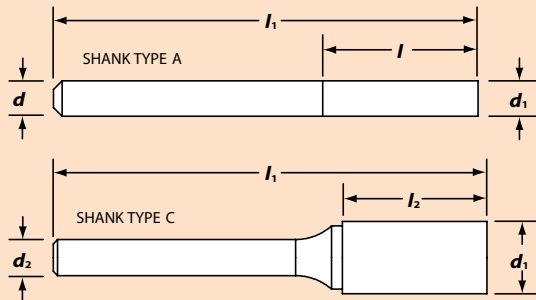
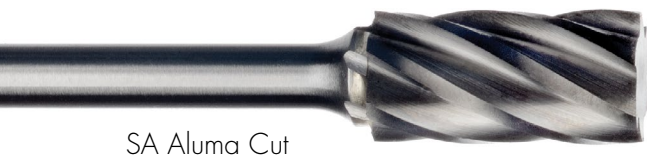

## SA - Metric

Tool Code	Cutter Dia d1	Shank Dia d2	Length of Cut l2	Overall Length l1	Shank Type	Standard Cut	Double Cut	Aluma Cut
SA-41M	1,5	3	6	38	A	60040	60080	
SA-42M	2,5	3	11	38	A	60041	60081	
SA-43M	3	3	14	38	A	60042	60082	
SA-43ML2	3	3	14	50	A	60065	60097	
SA-43ML3	3	3	14	75	A	60069	60101	
SA-11M	3	6	12	50	A	60043	60083	
SA-52M	4	3	12,7	38	B	60044	60084	
SA-53M	4,7	3	12,7	38	B	60045	60085	
SA-14M	4,7	6	16	50	A	60046	60086	
SA-1M	6	6	16	50	A	60048	60088	
SA-1M	6	6	19	50	A			60105
SA-1ML4	6	6	12,7	114	C	60066	60098	
SA-1ML6	6	6	12,7	163	C	60070	60102	
SA-51M	6,3	3	12,7	50	C	60047	60087	
SA-2M	8	6	20	63	C	60049	60089	
SA-3M	9,5	6	19	63	C	60058	60090	60106
SA-3MZ	10	6	20	64	C	64004	64104	
SA-3ML4	9,5	6	19	120	C	60067	60099	
SA-3ML6	9,5	6	19	171	C	60071	60103	
SA-4M	11	6	25	68	C	60059	60091	
SA-5MZ	12	6	25	68	C	64005	64105	
SA-5M	12,7	6	25	68	C	60060	60092	60107
SA-5ML4	12,7	6	25	127	C	60068	60100	
SA-5ML6	12,7	6	25	177	C	60072	60104	
SA-6M	16	6	25	68	C	60061	60093	60108
SA-7M	19	6	25	68	C	60063	60095	60109
SA-9M	25,4	6	25	68	C	60064	60096	

## SA - Inch

Tool Code	Cutter Dia d1	Shank Dia d2	Length of Cut l2	Overall Length l1	Shank Type	Standard Cut	Double Cut	Aluma Cut
SA-41	1/16	1/8	1/4	1-1/2	A	35066	35067	
SA-42	3/32	1/8	7/16	1-1/2	A	35071	35072	
SA-43	1/8	1/8	9/16	1-1/2	A	35076	35077	
SA-43L2	1/8	1/8	9/16	2	A	34906	34907	
SA-43L3	1/8	1/8	9/16	3	A	34909	90232	
SA-11	1/8	1/4	1/2	2	A	35011	35012	
SA-52	5/32	1/8	1/2	1-1/2	B	35096	35097	
SA-53	3/16	1/8	1/2	1-1/2	B	35101	35102	
SA-14	3/16	1/4	5/8	2	A	35021	35022	
SA-50	1/4	1/8	3/16	1-11/16	C	35086	35087	
SA-51	1/4	1/8	1/2	2	C	35091	35092	
SA-1	1/4	1/4	5/8	2	A	35001	35002	
SA-1	1/4	1/4	3/4	2	A			36230
SA-1A	1/4	1/4	1	2	A	35006	35007	
SA-1L4	1/4	1/4	1/2	4-1/2	C	35028	35030	
SA-1L6	1/4	1/4	1/2	6-1/2	C	34901	91185	
SA-2	5/16	1/4	3/4	2-3/4	C	35046	35047	
SA-3	3/8	1/4	3/4	2-3/4	C	35051	35052	36231
SA-3A	3/8	1/4	1	3	C	35056	35057	
SA-3L4	3/8	1/4	3/4	4-3/4	C	35033	35034	
SA-3L6	3/8	1/4	3/4	6-3/4	C	34903	34904	
SA-4	7/16	1/4	1	3	C	35061	35062	
SA-5	1/2	1/4	1	3	C	35081	35082	36232
SA-5L4	1/2	1/4	1	5	C	35038	35040	
SA-5L6	1/2	1/4	1	7	C	34911	91186	
SA-6	5/8	1/4	1	3	C	35106	35107	36233
SA-7	3/4	1/4	1	3	C	35121	35122	36234
SA-9	1	1/4	1	3	C	35136	35137	

# SB

## SB Cylindrical-Shape End-Cut Burs

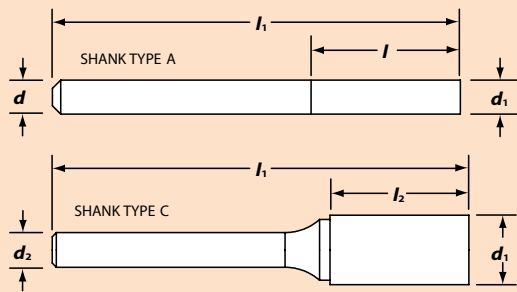

## SB - Metric

Tool Code	Cutter Dia d1	Shank Dia d2	Length of Cut l2	Overall Length l1	Shank Type	Standard Cut	Double Cut	Aluma Cut
SB-41M	1,5	3	6	38	A	60121	60140	
SB-42M	2,5	3	11	38	A	60122	60141	
SB-40M	3	3	No	38	A	60120		
SB-43M	3	3	14	38	A	60123	60142	
SB-43ML2	3	3	14	50	A	60578	60579	
SB-43ML3	3	3	14	75	A	60586	60587	
SB-11M	3	6	12	50	A	60124	60143	
SB-52M	4	3	12,7	38	B	60125	60144	
SB-53M	4,7	3	12,7	38	B	60126	60145	
SB-14M	4,7	6	16	50	A	60127	60146	
SB-1M	6	6	16	50	A	60130	60149	
SB-1M	6	6	19	50	A			60160
SB-1ML4	6	6	12,7	114	C	60580	60581	
SB-1ML6	6	6	12,7	163	C	60588	60589	
SB-50M	6,3	3	5	43	C	60128	60147	
SB-51M	6,3	3	12,7	50	C	60129	60148	
SB-2M	8	6	20	63	C	60131	60150	
SB-3M	9,5	6	19	63	C	60132	60151	60161
SB-3MZ	10	6	20	64	C	64012	64112	
SB-3ML4	9,5	6	19	120	C	60582	60583	
SB-3ML6	9,5	6	19	171	C	60590	60591	
SB-4M	11	6	25	68	C	60133	60152	
SB-5MZ	12	6	25	68	C	64013	64113	
SB-5M	12,7	6	25	68	C	60134	60153	60162
SB-5ML4	12,7	6	25	127	C	60584	60585	
SB-5ML6	12,7	6	25	177	C	60592	60593	
SB-6M	16	6	25	68	C	60135	60154	60163
SB-7M	19	6	25	68	C	60137	60156	60164

## SB - Inch

Tool Code	Cutter Dia d1	Shank Dia d2	Length of Cut l2	Overall Length l1	Shank Type	Standard Cut	Double Cut	Aluma Cut
SB-41	1/16	1/8	1/4	1-1/2	A	35216	35217	
SB-42	3/32	1/8	7/16	1-1/2	A	35221	35222	
SB-40	1/8	1/8	No	1-1/2	A	36161		
SB-43	1/8	1/8	9/16	1-1/2	A	35226	35227	
SB-43L2	1/8	1/8	9/16	2	A	35803	95234	
SB-43L3	1/8	1/8	9/16	3	A	96806	98586	
SB-11	1/8	1/4	1/2	2	A	35161	35162	
SB-52	5/32	1/8	1/2	1-1/2	B	35246	35247	
SB-53	3/16	1/8	1/2	1-1/2	B	35251	35252	
SB-14	3/16	1/4	5/8	2	A	35171	35172	
SB-50	1/4	1/8	3/16	1-11/16	C	35236	35237	
SB-51	1/4	1/8	1/2	2	C	35241	35242	
SB-0	1/4	1/4	No	2	A	36156		
SB-1	1/4	1/4	5/8	2	A	35151	35152	
SB-1	1/4	1/4	3/4	2	A			36264
SB-1A	1/4	1/4	1	2	A	35156	35157	
SB-1L4	1/4	1/4	1/2	4-1/2	C	35820	35805	
SB-1L6	1/4	1/4	1/2	6-1/2	C	35831	35813	
SB-2	5/16	1/4	3/4	2-3/4	C	35196	35197	
SB-3	3/8	1/4	3/4	2-3/4	C	35201	35202	36265
SB-3A	3/8	1/4	1	3	C	35206	35207	
SB-3L4	3/8	1/4	3/4	4-3/4	C	35823	35808	
SB-3L6	3/8	1/4	3/4	6-3/4	C	35828	35815	
SB-4	7/16	1/4	1	3	C	35211	35212	
SB-5	1/2	1/4	1	3	C	35231	35232	36266
SB-5L4	1/2	1/4	1	5	C	35825	35810	
SB-5L6	1/2	1/4	1	7	C	35830	35818	
SB-6	5/8	1/4	1	3	C	35256	35257	36267
SB-7	3/4	1/4	1	3	C	35271	35272	36268

## SC Radius-End Cylindrical-Shape Burs



### SC - Metric

Tool Code	Cutter Dia d1	Shank Dia d2	Length of Cut l2	Overall Length l1	Shank Type	Standard Cut	Double Cut	Aluma Cut
SC-41M	2,5	3	11	38	A	60170	60192	
SC-42M	3	3	14	38	A	60171	60193	
SC-42ML2	3	3	14	50	A	60184	60206	
SC-42ML3	3	3	14	75	A	60188	60210	
SC-11M	3	6	12	50	A	60172	60194	
SC-52M	4	3	12,7	38	B	60173	60195	
SC-53M	4,7	3	12,7	38	B	60174	60196	
SC-14M	4,7	6	16	50	A	60175	60197	
SC-1M	6	6	16	50	A	60177	60199	
SC-1M	6	6	19	50	A			60215
SC-1ML4	6	6	12,7	114	C	60185	60207	
SC-1ML6	6	6	12,7	163	C	60189	60211	
SC-51M	6,3	3	12,7	50	C	60176	60198	
SC-2M	8	6	20	63	C	60178	60200	
SC-3M	9,5	6	19	63	C	60179	60201	60216
SC-3MZ	10	6	20	64	C	64020	64120	
SC-3ML4	9,5	6	19	120	C	60186	60208	
SC-3ML6	9,5	6	19	171	C	60190	60212	
SC-4M	11	6	25	68	C	60180	60202	
SC-5MZ	12	6	25	68	C	64021	64121	
SC-5M	12,7	6	25	68	C	60181	60203	60217
SC-5ML4	12,7	6	25	127	C	60187	60209	
SC-5ML6	12,7	6	25	177	C	60191	60213	
SC-6M	16	6	25	68	C	60182	60204	60218
SC-7M	19	6	25	68	C	60183	60205	60219

### SC - Inch

Tool Code	Cutter Dia d1	Shank Dia d2	Length of Cut l2	Overall Length l1	Shank Type	Standard Cut	Double Cut	Aluma Cut
SC-41	3/32	1/8	7/16	1-1/2	A	35346	35347	
SC-42	1/8	1/8	9/16	1-1/2	A	35351	35352	
SC-42L2	1/8	1/8	9/16	2	A	34919	34920	
SC-42L3	1/8	1/8	9/16	3	A	34922	34923	
SC-11	1/8	1/4	1/2	2	A	35311	35312	
SC-52	5/32	1/8	1/2	1-1/2	A	35366	35367	
SC-53	3/16	1/8	1/2	1-1/2	A	35371	35372	
SC-14	3/16	1/4	5/8	2	A	35321	35322	
SC-51	1/4	1/8	1/2	2	C	35361	35362	
SC-1	1/4	1/4	5/8	2	A	35301	35302	
SC-1	1/4	1/4	3/4	2	A			36236
SC-1A	1/4	1/4	1	2	A	35306	35307	
SC-1L4	1/4	1/4	1/2	4-1/2	C	35410	35411	
SC-1L6	1/4	1/4	1/2	6-1/2	C	34913	34914	
SC-2	5/16	1/4	3/4	2-3/4	C	35326	35327	
SC-3	3/8	1/4	3/4	2-3/4	C	35331	35332	36237
SC-3A	3/8	1/4	1	3	C	35336	35337	
SC-3L4	3/8	1/4	3/4	4-3/4	C	35412	35413	
SC-3L6	3/8	1/4	3/4	6-3/4	C	34916	34917	
SC-4	7/16	1/4	1	3	C	35341	35342	
SC-5	1/2	1/4	1	3	C	35356	35357	36238
SC-5L4	1/2	1/4	1	5	C	35414	35415	
SC-5L6	1/2	1/4	1	7	C	34925	34926	
SC-6	5/8	1/4	1	3	C	35376	35377	36239
SC-7	3/4	1/4	1	3	C	35386	35387	36240

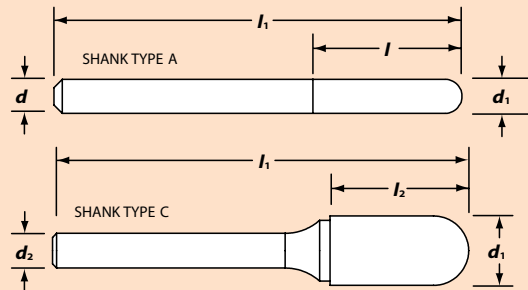

# SD

## SD Ball-Shape Burs

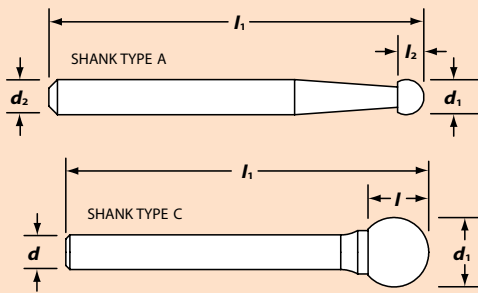

## SD - Metric

Tool Code	Cutter Dia d1	Shank Dia d2	Length of Cut l2	Overall Length l1	Shank Type	Standard Cut	Double Cut	Aluma Cut
SD-41M	2,3	3	2	38	A	60220	60242	
SD-42M	3	3	2	38	A	60221	60243	
SD-42ML2	3	3	2	50	A	60234	60256	
SD-42ML3	3	3	2	75	A	60238	60260	
SD-11M	3	6	2	50	A	60222	60244	
SD-53M	4,7	3	4,5	38	B	60223	60245	
SD-14M	4,7	6	4,5	50	A	60224	60246	
SD-1M	6	6	5	50	A	60226	60248	60265
SD-51M	6,3	3	5	43	C	60225	60247	
SD-1ML4	6,3	6	5	107	C	60235	60257	
SD-1ML6	6,3	6	5	157	C	60239	60261	
SD-2M	8	6	7	50	A	60227	60249	60266
SD-3M	9,5	6	8	52	C	60228	60250	
SD-3ML4	9,5	6	8	108	C	60236	60258	
SD-3ML6	9,5	6	8	161	C	60240	60262	
SD-3MZ	10	6	9	52	C	64047	64147	
SD-4M	11	6	9,5	52	C	60229	60251	
SD-5MZ	12	6	10	54	C	64048	64148	
SD-5M	12,7	6	11	54	C	60230	60252	60267
SD-5ML4	12,7	6	11	111	C	60237	60259	
SD-5ML6	12,7	6	11	164	C	60241	60263	
SD-6M	16	6	14	58	C	60231	60253	60268
SD-7M	19	6	16	60	C	60232	60254	60269
SD-9M	25,4	6	24	68	C	60233	60255	

## SD - Inch

Tool Code	Cutter Dia d1	Shank Dia d2	Length of Cut l2	Overall Length l1	Shank Type	Standard Cut	Double Cut	Aluma Cut
SD-41	3/32	1/8	1/16	1-1/2	A	35446	35447	
SD-42	1/8	1/8	3/32	1-1/2	A	35451	35452	
SD-42L2	1/8	1/8	3/32	2	A	34934	34935	
SD-42L3	1/8	1/8	3/32	3	A	34937	34938	
SD-11	1/8	1/4	3/32	2	A	35421	35422	
SD-53	3/16	1/8	1/8	1-1/2	A	35466	35467	
SD-14	3/16	1/4	5/32	2	A	35426	35427	
SD-51	1/4	1/8	7/32	1-11/16	C	35461	35462	
SD-1	1/4	1/4	7/32	2	A	35416	35417	36242
SD-1L4	1/4	1/4	7/32	4-1/8	C	35505	35506	
SD-1L6	1/4	1/4	7/32	6-1/8	C	34928	34929	
SD-2	5/16	1/4	1/4	2-1/4	C	35431	35432	
SD-3	3/8	1/4	5/16	2-5/16	C	35436	35437	36243
SD-3L4	3/8	1/4	5/16	4-1/4	C	35507	35508	
SD-3L6	3/8	1/4	5/16	6-1/4	C	34931	34932	
SD-4	7/16	1/4	3/8	2-3/8	C	35441	35442	
SD-5	1/2	1/4	7/16	2-7/16	C	35456	35457	36244
SD-5L4	1/2	1/4	7/16	4-3/8	C	35509	35510	
SD-5L6	1/2	1/4	7/16	6-3/8	C	34940	34941	
SD-6	5/8	1/4	9/16	2-9/16	C	35471	35472	36245
SD-7	3/4	1/4	11/16	2-11/16	C	35481	35482	36246
SD-9	1	1/4	15/16	2-15/16	C	35496	35497	

# SE

## SE Oval-Shape Burs



SE Standard Cut



SE Double Cut



SE Aluma Cut

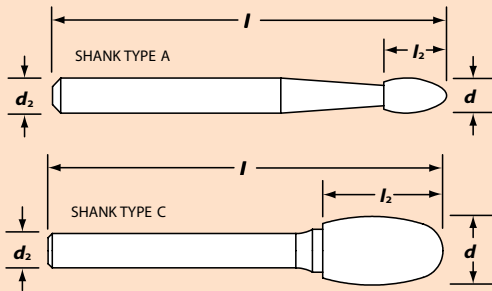

## SE - Metric

Tool Code	Cutter Dia $d_1$	Shank Dia $d_2$	Length of Cut $l_2$	Overall Length $l_1$	Shank Type	Standard Cut	Double Cut	Aluma Cut
SE-41M	3	3	5	38	A	60270	60286	
SE-41ML2	3	3	5	50	A	60278	60304	
SE-41ML3	3	3	5	76	A	60282	60308	
SE-53M	4,7	3	7,1	38	A	60271	60287	
SE-1M	6	6	10	50	A	60273	60289	60312
SE-51M	6,3	3	9,5	47	C	60272	60288	
SE-1ML4	6,3	6	10	111	C	60279	60305	
SE-1ML6	6,3	6	10	163	C	60283	60309	
SE-3M	9,5	6	16	60	C	60274	60300	60313
SE-3ML4	9,5	6	16	117	C	60280	60306	
SE-3ML6	9,5	6	16	168	C	60284	60310	
SE-5M	12,7	6	22	66	C	60275	60301	60314
SE-5ML4	12,7	6	22	123	C	60281	60307	
SE-5ML6	12,7	6	22	177	C	60285	60311	
SE-6M	16	6	25	68	C	60276	60302	60315
SE-7M	19	6	25	68	C	60277	60303	60316

## SE - Inch

Tool Code	Cutter Dia $d_1$	Shank Dia $d_2$	Length of Cut $l_2$	Overall Length $l_1$	Shank Type	Standard Cut	Double Cut	Aluma Cut
SE-41	1/8	1/8	7/32	1-1/2	A	35521	35522	
SE-41L2	1/8	1/8	7/32	2	A	34949	34950	
SE-41L3	1/8	1/8	7/32	3	A	91340	34952	
SE-53	3/16	1/8	9/32	1-1/2	A	35536	35537	
SE-51	1/4	1/8	3/8	1-7/8	C	35531	35532	
SE-1	1/4	1/4	3/8	2	A	35511	35512	36247
SE-1L4	1/4	1/4	3/8	4-3/8	C	35557	35558	
SE-1L6	1/4	1/4	3/8	6-3/8	C	34943	34944	
SE-3	3/8	1/4	5/8	2-5/8	C	35516	35517	36248
SE-3L4	3/8	1/4	5/8	4-5/8	C	35559	35560	
SE-3L6	3/8	1/4	5/8	6-5/8	C	34946	34947	
SE-5	1/2	1/4	7/8	2-7/8	C	35526	35527	36249
SE-5L4	1/2	1/4	7/8	4-7/8	C	35563	35565	
SE-5L6	1/2	1/4	7/8	6-7/8	C	90292	11332	
SE-6	5/8	1/4	1	3	C	35541	35542	36250
SE-7	3/4	1/4	1	3	C	35551	35552	36251

# SF

## SF Tree-Shape Radius-End Burs



## SF - Metric

Tool Code	Cutter Dia d1	Shank Dia d2	Length of Cut l2	Overall Length l1	Shank Type	Standard Cut	Double Cut	Aluma Cut
SF-41M	3	3	6,3	38	A	60320	60342	
SF-42M	3	3	13	38	A	60321	60343	
SF-42ML2	3	3	13	50	A	60334	60356	
SF-42ML3	3	3	13	75	A	60338	60360	
SF-11M	3	6	13	50	A	60322	60344	
SF-53M	4,7	3	13	38	B	60323	60345	
SF-1M	6	6	19	50	A	60325	60347	60365
SF-1ML4	6	6	13	114	C	60335	60357	
SF-1ML6	6	6	13	163	C	60339	60361	
SF-51M	6,3	3	13	50	C	60324	60346	
SF-3M	9,5	6	19	63	C	60326	60348	60366
SF-3ML4	9,5	6	19	120	C	60336	60358	
SF-3ML6	9,5	6	19	171	C	60340	60362	
SF-4M	11	6	25	68	C	60327	60349	
SF-5MZ	12	6	25	68	C	64027	64127	
SF-13M	12,7	6	19	63	C	60328	60350	
SF-5M	12,7	6	25	68	C	60329	60351	60367
SF-5ML4	12,7	6	25	127	C	60337	60359	
SF-5ML6	12,7	6	25	177	C	60341	60363	
SF-6M	16	6	25	68	C	60330	60352	60368
SF-7M	19	6	25	68	C	60331	60353	
SF-14M	19	6	32	76	C	60332	60354	60369
SF-15M	19	6	38	82	C	60333	60355	

## SF - Inch

Tool Code	Cutter Dia d1	Shank Dia d2	Length of Cut l2	Overall Length l1	Shank Type	Standard Cut	Double Cut	Aluma Cut
SF-41	1/8	1/8	1/4	1-1/2	A	35616	35617	
SF-42	1/8	1/8	1/2	1-1/2	A	35621	35622	
SF-42L2	1/8	1/8	1/2	2	A	34961	34962	
SF-42L3	1/8	1/8	1/2	3	A	91343	11326	
SF-11	1/8	1/4	1/2	2	A	35576	35577	
SF-53	3/16	1/8	1/2	1-1/2	A	35636	35637	
SF-51	1/4	1/8	1/2	2	C	35631	35632	
SF-1	1/4	1/4	3/4	2	A	35571	35572	36253
SF-1L4	1/4	1/4	1/2	4-1/2	C	35592	35593	
SF-1L6	1/4	1/4	1/2	6-1/2	C	34955	34956	
SF-3	3/8	1/4	3/4	2-3/4	C	35606	35607	36254
SF-3L4	3/8	1/4	3/4	4-3/4	C	35594	35595	
SF-3L6	3/8	1/4	3/4	6-3/4	C	34958	34959	
SF-4	7/16	1/4	1	3	C	35611	35612	
SF-13	1/2	1/4	3/4	2-3/4	C	35581	35582	
SF-5	1/2	1/4	1	3	C	35626	35627	36255
SF-5L4	1/2	1/4	1	5	C	35598	35600	
SF-5L6	1/2	1/4	1	7	C	34965	34966	
SF-6	5/8	1/4	1	3	C	35641	35642	36256
SF-7	3/4	1/4	1	3	C	35651	35652	
SF-14	3/4	1/4	1-1/4	3-1/4	C	35586	35587	36257
SF-15	3/4	1/4	1-1/2	3-1/2	C	35596	35597	

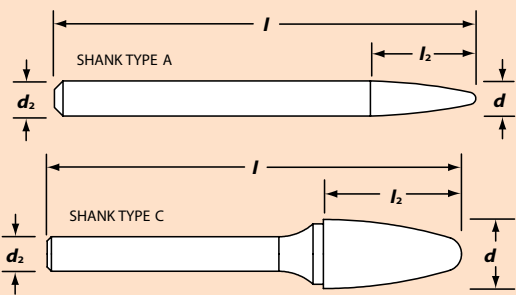

## SG Pointed-End Tree-Shape Burs

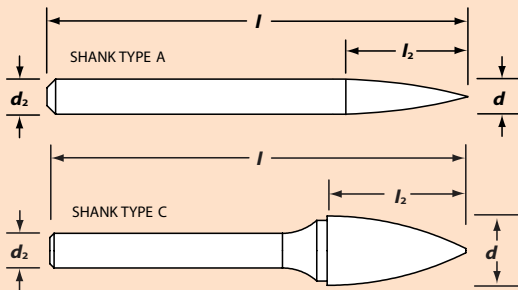

## SG - Metric

Tool Code	Cutter Dia d1	Shank Dia d2	Length of Cut l2	Overall Length l1	Shank Type	Standard Cut	Double Cut
SG-41M	3	3	6,3	38	A	60370	60391
SG-43M	3	3	9,5	38	A	60371	60392
SG-44M	3	3	13	38	A	60372	60393
SG-44ML2	3	3	13	50	A	60383	60404
SG-44ML3	3	3	13	75	A	60387	60408
SG-53M	4,7	3	13	38	B	60373	60394
SG-1M	6	6	19	50	A	60375	60396
SG-1ML4	6	6	13	114	C	60384	60405
SG-1ML6	6	6	13	163	C	60388	60409
SG-51M	6,3	3	13	50	C	60374	60395
SG-2M	8	6	19	63	C	60376	60397
SG-3M	9,5	6	19	63	C	60377	60398
SG-3ML4	9,5	6	19	120	C	60385	60406
SG-3ML6	9,5	6	19	171	C	60389	60410
SG-3MZ	10	6	20	64	C	64033	64133
SG-5MZ	12	6	25	68	C	64034	64134
SG-13M	12,7	6	19	63	C	60378	60399
SG-5M	12,7	6	25	68	C	60379	60400
SG-5ML4	12,7	6	25	127	C	60386	60407
SG-5ML6	12,7	6	25	177	C	60390	60411
SG-6M	16	6	25	68	C	60380	60401
SG-7M	19	6	25	68	C	60381	60402
SG-15M	19	6	38	82	C	60382	60403

## SG - Inch

Tool Code	Cutter Dia d1	Shank Dia d2	Length of Cut l2	Overall Length l1	Shank Type	Standard Cut	Double Cut
SG-41	1/8	1/8	1/4	1-1/2	A	35701	35702
SG-42	1/8	1/8	5/16	1-1/2	A	35706	35707
SG-43	1/8	1/8	3/8	1-1/2	A	35711	35712
SG-44	1/8	1/8	1/2	1-1/2	A	36155	93853
SG-44L2	1/8	1/8	1/2	2	A	34974	34975
SG-44L3	1/8	1/8	1/2	3	A	34977	34978
SG-53	3/16	1/8	1/2	1-1/2	A	11320	11602
SG-51	1/4	1/8	1/2	2	C	35721	35722
SG-1	1/4	1/4	3/4	2	A	35671	35672
SG-1L4	1/4	1/4	1/2	4-1/2	C	35738	35740
SG-1L6	1/4	1/4	1/2	6-1/2	C	34968	34969
SG-2	5/16	1/4	3/4	2-3/4	C	35691	35692
SG-3	3/8	1/4	3/4	2-3/4	C	35696	35697
SG-3L4	3/8	1/4	3/4	4-3/4	C	35700	35743
SG-3L6	3/8	1/4	3/4	6-3/4	C	34971	34972
SG-13	1/2	1/4	3/4	2-3/4	C	35676	35677
SG-5	1/2	1/4	1	3	C	35716	35717
SG-5L4	1/2	1/4	1	5	C	35713	35745
SG-5L6	1/2	1/4	1	7	C	91029	90426
SG-6	5/8	1/4	1	3	C	35726	35727
SG-7	3/4	1/4	1	3	C	35736	35737
SG-15	3/4	1/4	1-1/2	3-1/2	C	35681	35682

# SH

## SH Flame-Shape Burs

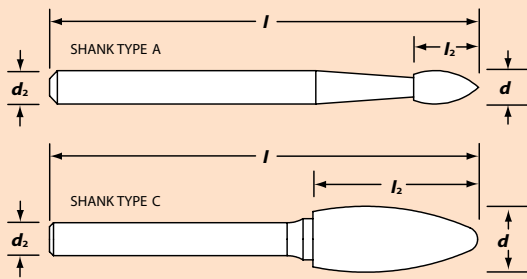

## SH - Metric

Tool Code	Cutter Dia d1	Shank Dia d2	Length of Cut l2	Overall Length l1	Shank Type	Standard Cut	Double Cut
SH-41M	3	3	6	38	A	60414	60427
SH-41ML2	3	3	6	50	A	60421	60434
SH-41ML3	3	3	6	76	A	60424	60437
SH-53M	4,7	3	9,5	38	A	60415	60428
SH-1M	6	6	16	50	A	60416	60429
SH-2M	8	6	19	63	C	60417	60430
SH-2ML4	8	6	19	120	C	60422	60435
SH-2ML6	8	6	19	171	C	60425	60438
SH-5M	12,7	6	31	75	C	60418	60431
SH-5ML4	12,7	6	31	132	C	60423	60436
SH-5ML6	12,7	6	31	183	C	60426	60439
SH-6M	16	6	36	79	C	60419	60432
SH-7M	19	6	41	84	C	60420	60433

## SH - Inch

Tool Code	Cutter Dia d1	Shank Dia d2	Length of Cut l2	Overall Length l1	Shank Type	Standard Cut	Double Cut
SH-41	1/8	1/8	1/4	1-1/2	A	35766	35767
SH-41L2	1/8	1/8	1/4	2	A	34984	34985
SH-41L3	1/8	1/8	1/4	3	A	34987	34988
SH-53	3/16	1/8	3/8	1-1/2	A	35776	35777
SH-1	1/4	1/4	5/8	2	A	35756	35757
SH-2	5/16	1/4	3/4	2-3/4	C	35761	35762
SH-2L4	5/16	1/4	3/4	4-3/4	C	35800	35794
SH-2L6	5/16	1/4	3/4	6-3/4	C	34981	34982
SH-5	1/2	1/4	1-1/4	3-1/4	C	35771	35772
SH-5L4	1/2	1/4	1-1/4	5-1/4	C	35832	35798
SH-5L6	1/2	1/4	1-1/4	7-1/4	C	34990	34991
SH-6	5/8	1/4	1-7/16	3-7/16	C	35781	35782
SH-7	3/4	1/4	1-5/8	3-5/8	C	35786	35787

# SL

## SL Taper-Shape Burs

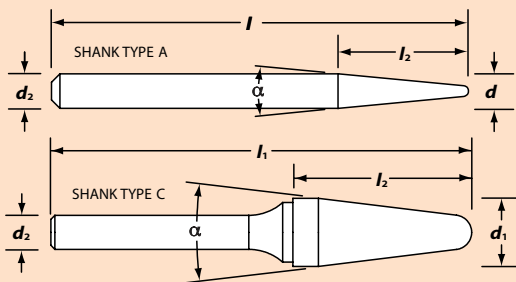

## SL - Metric

Tool Code	Cutter Dia d1	Shank Dia d2	Length of Cut l2	Overall Length l1	Incl. Angle	Shank Type	Standard Cut	Double Cut	Aluma Cut
SL-41M	3	3	9,5	38	10°	A	60440	60458	
SL-42M	3	3	12	38	8°	A	60441	60460	
SL-42ML2	3	3	12	50	8°	A	60449	60469	
SL-42ML3	3	3	12	76	8°	A	60453	60473	
SL-53M	4,7	3	12	38	14°	A	60442	60461	
SL-1M	6	6	16	50	14°	A	60443	60462	60478
SL-1ML4	6	6	16	117	14°	C	60450	60470	
SL-1ML6	6	6	16	168	14°	C	60454	60474	
SL-2M	8	6	22	66	14°	C	60444	60463	
SL-3M	9,5	6	27	71	14°	C	60445	60464	60479
SL-3ML4	9,5	6	27	127	14°	C	60451	60471	
SL-3ML6	9,5	6	27	179	14°	C	60455	60475	
SL-4M	12,7	6	28	72	14°	C	60446	60465	60480
SL-4ML4	12,7	6	28	129	14°	C	60452	60472	
SL-4ML6	12,7	6	28	180	14°	C	60456	60477	
SL-6M	16	6	30	76	14°	C	60447	60466	60481
SL-7M	19	6	38	82	14°	C	60448	60467	60482

## SL - Inch

Tool Code	Cutter Dia d1	Shank Dia d2	Length of Cut l2	Overall Length l1	Incl. Angle	Shank Type	Standard Cut	Double Cut	Aluma Cut
SL-41	1/8	1/8	3/8	1-1/2	10°	A	35921	35922	
SL-42	1/8	1/8	1/2	1-1/2	8°	A	35926	35927	
SL-42L2	1/8	1/8	1/2	2	8°	A	34815	34816	
SL-42L3	1/8	1/8	1/2	3	8°	A	34818	34819	
SL-53	3/16	1/8	1/2	1-1/2	14°	A	35931	35932	
SL-1	1/4	1/4	5/8	2	14°	A	35901	35902	36258
SL-1L4	1/4	1/4	5/8	4-5/8	14°	C	35947	35948	
SL-1L6	1/4	1/4	5/8	6-5/8	14°	C	34807	34808	
SL-2	5/16	1/4	7/8	2-7/8	14°	C	35906	35907	
SL-3	3/8	1/4	1-1/16	3-1/16	14°	C	35911	35912	36259
SL-3L4	3/8	1/4	1-1/16	5	14°	C	35949	35950	
SL-3L6	3/8	1/4	1-1/16	7	14°	C	34810	34811	
SL-4	1/2	1/4	1-1/8	3-1/8	14°	C	35916	35917	36260
SL-4L4	1/2	1/4	1-1/8	5-1/8	14°	C	35953	35955	
SL-4L6	1/2	1/4	1-1/8	7-1/8	14°	C	91028	34813	
SL-6	5/8	1/4	1-5/16	3-5/16	14°	C	35936	35937	36261
SL-7	3/4	1/4	1-1/2	3-1/2	14°	C	35941	35942	36262

# SM

## SM Cone-Shape Burs

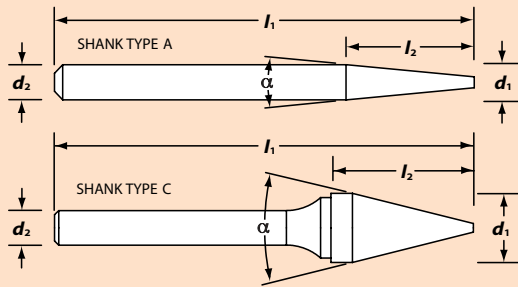

## SM - Metric

Tool Code	Cutter Dia d1	Shank Dia d2	Length of Cut l2	Overall Length l1	Incl. Angle	Shank Type	Standard Cut	Double Cut
SM-41M	3	3	8,7	38	12°	A	60485	60496
SM-42M	3	3	11	38	14°	A	60486	60497
SM-43M	3	3	16	38	7°	A	60487	60498
SM-53M	4,7	3	12,7	38	16°	A	60488	60499
SM-1M	6	6	12,7	50	22°	A	60490	60501
SM-2M	6	6	18	50	14°	A	60491	60502
SM-3M	6	6	25	50	10°	A	60492	60503
SM-51M	6,3	3	12,7	50	22°	C	60489	60500
SM-4M	9,5	6	16	60	28°	C	60493	60504
SM-5M	12,7	6	22	66	28°	C	60494	60505
SM-6M	16	6	25	68	31°	C	60495	60506

## SM - Inch

Tool Code	Cutter Dia d1	Shank Dia d2	Length of Cut l2	Overall Length l1	Incl. Angle	Shank Type	Standard Cut	Double Cut
SM-41	1/8	1/8	11/32	1-1/2	12°	A	35976	35977
SM-42	1/8	1/8	7/16	1-1/2	14°	A	35981	35982
SM-43	1/8	1/8	5/8	1-1/2	7°	A	35986	35987
SM-53	3/16	1/8	1/2	1-1/2	16°	A	36001	36002
SM-51	1/4	1/8	1/2	2	22°	C	35996	35997
SM-1	1/4	1/4	1/2	2	22°	A	35956	35957
SM-2	1/4	1/4	3/4	2	14°	A	35961	35962
SM-3	1/4	1/4	1	2	10°	A	35966	35967
SM-4	3/8	1/4	5/8	2-5/8	28°	C	35971	35972
SM-5	1/2	1/4	7/8	2-7/8	28°	C	35991	35992
SM-6	5/8	1/4	1	3	31°	C	36006	36007

# SJ

## SJ Cone-Shape Countersink Burs

### 60°

Often called multi-flute countersinks, use these tools for improved finishes and closer tolerance countersinking in general-purpose operations. May be used in high-production equipment.



SJ Standard Cut



SJ Double Cut

### SJ 60° - Metric

Tool Code	Cutter Dia d1	Shank Dia d2	Length of Cut l2	Overall Length l1	Max Tip d3	Shank Type	Standard Cut	Double Cut
SJ-42M	3	3	2	38	To Point	A	60508	60532
SJ-1M	6	6	5	50	To Point	A	60510	60534
SJ-3M	9,5	6	8	55	1	C	60511	60535
SJ-5M	12,7	6	11	58	1	C	60512	60536
SJ-6M	16	6	14	60	1,5	C	60513	60537
SJ-7M	19	6	16	64	1,5	C	60514	60538
SJ-9M	25,4	6	23	68	3	C	60515	60539

### SJ 60° - Inch

Tool Code	Cutter Dia d1	Shank Dia d2	Length of Cut l2	Overall Length l1	Max Tip d3	Shank Type	Standard Cut	Double Cut
SJ-42	1/8	1/8	3/32	1-1/2	To Point	A	35811	35812
SJ-1	1/4	1/4	3/16	2	To Point	A	35801	35802
SJ-3	3/8	1/4	5/16	2-7/16	1/32	C	35806	35807
SJ-5	1/2	1/4	7/16	2-9/16	1/32	C	35816	35817
SJ-6	5/8	1/4	9/16	2-11/16	1/16	C	35821	35822
SJ-7	3/4	1/4	11/16	2-13/16	1/16	C	35826	35827
SJ-9	1	1/4	15/16	2-15/16	1/8	C	35841	35842

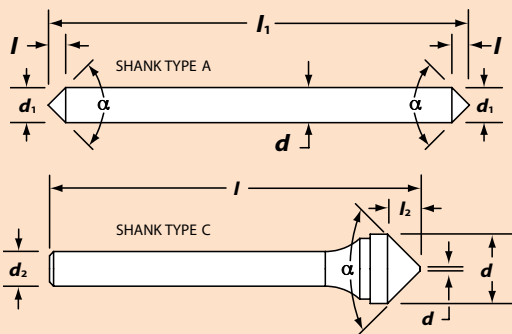

# ST/SK

## ST/SK Cone-Shape Countersink Burs

### ST-82° SK-90°

Often called multi-flute countersinks, use these tools for improved finishes and closer tolerance countersinking in general-purpose operations. May be used in high-production equipment.



ST/SK Standard Cut



ST/SK Double Cut

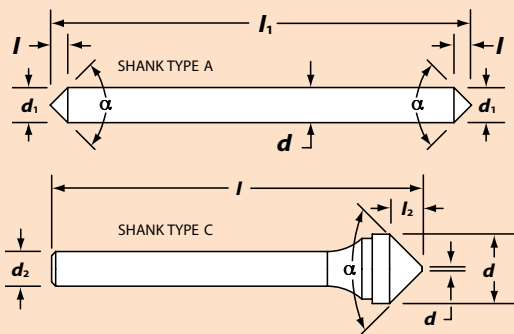

## SK 90° - Metric

Tool Code	Cutter Dia d1	Shank Dia d2	Length of Cut l2	Overall Length l1	Max Tip d3	Shank Type	Standard Cut	Double Cut
SK-42M	3	3	1	38	To Point	A	60524	60548
SK-1M	6	6	3	50	To Point	A	60526	60550
SK-3M	9,5	6	4,7	52	1	C	60527	60551
SK-5M	12,7	6	6,3	52	1	C	60528	60552
SK-6M	16	6	8	56	1,5	C	60529	60553
SK-7M	19	6	9	58	1,5	C	60530	60554
SK-9M	25,4	6	12,7	60	3	C	60531	60555

## SK 90° - Inch

Tool Code	Cutter Dia d1	Shank Dia d2	Length of Cut l2	Overall Length l1	Max Tip d3	Shank Type	Standard Cut	Double Cut
SK-42	1/8	1/8	1/16	1-1/2	To Point	A	35861	35862
SK-1	1/4	1/4	1/8	2	To Point	A	35851	35852
SK-3	3/8	1/4	3/16	2-5/16	1/32	C	35856	35857
SK-5	1/2	1/4	1/4	2-3/8	1/32	C	35866	35867
SK-6	5/8	1/4	5/16	2-1/2	1/16	C	35871	35872
SK-7	3/4	1/4	3/8	2-9/16	1/16	C	35876	35877
SK-9	1	1/4	1/2	2-11/16	1/8	C	35891	35892

## ST 82° - Inch

Tool Code	Cutter Dia d1	Shank Dia d2	Length of Cut l2	Overall Length l1	Max Tip d3	Shank Type	Standard Cut	Double Cut
ST-42	1/8	1/8	1/16	1-1/2	To Point	A	36164	36165
ST-1	1/4	1/4	1/8	2	To Point	A	36166	36167
ST-3	3/8	1/4	3/16	2-5/16	1/32	C	36171	36172
ST-5	1/2	1/4	1/4	2-3/8	1/32	C	36176	36177
ST-6	5/8	1/4	5/16	2-1/2	1/16	C	36181	36182
ST-7	3/4	1/4	3/8	2-9/16	1/16	C	36186	36187
ST-9	1	1/4	1/2	2-11/16	1/8	C	36191	36192

# SN

## SN Inverted Cone-Shape Burs



SN Standard Cut



SN Double Cut

## SN - Metric

Tool Code	Cutter Dia d1	Shank Dia d2	Length of Cut l2	Overall Length l1	Incl. Angle	Shank Type	Standard Cut	Double Cut
SN-41M	2,3	3	3	38	10°	A	60556	60566
SN-42M	3	3	5	38	10°	A	60557	60567
SN-53M	4,7	3	6,3	38	10°	A	60558	60568
SN-1M	6	6	8	50	10°	A	60560	60570
SN-51M	6,3	3	6,3	44	10°	C	60559	60569
SN-2M	9,5	6	9,5	52	13°	C	60561	60571
SN-3M	12,7	6	12,7	56	16°	C	60562	60572
SN-4M	12,7	6	12,7	56	28°	C	60563	60573
SN-5M	16	6	16	60	19°	C	60564	60574
SN-6M	16	6	19	63	18°	C	60577	60575
SN-8M	19	6	19	63	21°	C	60565	60576

## SN - Inch

Tool Code	Cutter Dia d1	Shank Dia d2	Length of Cut l2	Overall Length l1	Incl. Angle	Shank Type	Standard Cut	Double Cut
SN-41	3/32	1/8	1/8	1-1/2	10°	A	36041	36042
SN-42	1/8	1/8	3/16	1-1/2	10°	A	36046	36047
SN-53	3/16	1/8	1/4	1-1/2	10°	A	36056	36057
SN-51	1/4	1/8	1/4	1-3/4	10°	C	36051	36052
SN-1	1/4	1/4	5/16	2	10°	A	36026	36027
SN-2	3/8	1/4	3/8	2-3/8	13°	C	36031	36032
SN-3	1/2	1/4	1/2	2-1/2	16°	C	36035	36038
SN-4	1/2	1/4	1/2	2-1/2	28°	C	36036	36037
SN-5	5/8	1/4	5/8	2-5/8	19°	C	36068	36069
SN-6	5/8	1/4	3/4	2-3/4	18°	C	36061	36062
SN-8	3/4	1/4	3/4	2-3/4	21°	C	36075	36076

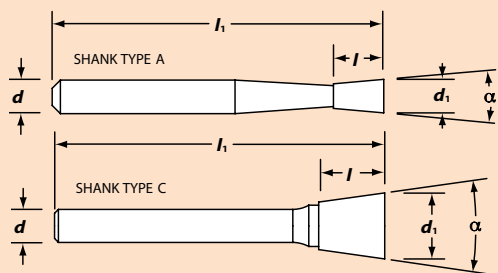

## Having a Hard Time Deburring?

Sometimes the basic fluting options don't hold up in very hard materials. **IMCO can provide styles available by special order when standard tooling will not work for an application.** For example, a fine cut flute style features an increased number of flutes in combination with the shallow flute depth of the fine cut design to improve edge strength. This stronger tool design extends tool life by reducing edge chipping and tool chatter while also leaving a better part finish.

In aerospace materials such as titanium and nickel-based alloys, try IMCO's coarse cut burs. This "open" fluting style allows for better chip evacuation while retaining cutting edge strength. Try this when working in materials with low machinability ratings.

Material packing can be an issue in ferrous materials. Special order burs with negative rake in standard, double or fine cut fluting styles may help. The negative rake keeps material from being pulled into the flute, eliminating evacuation issues. Please note: The negative rake does reduce the shearing action of the bur and should only be considered for applications in which chip packing is an issue.



# BUR SETS

## Bur Sets

Convenient sets with varying assortments of our most popular burs. Double Cut and Standard Cut sets available.



Set #2



Set #1



Set #6

## Bur Sets - Metric

Tool Code	Shank Dia d2	No. of Pieces	Bur Set Contents	Standard Cut	Double Cut
Set #1M	3	12	SA-42M,SA-43M,SC-41M,SC-42M,SD-42M,SE-41M,SF-42M,SG-44M,SH-41M,SL-42M,SM-42M,SN-42M	36203	36205
Set #2M	3	9	SA-51M,SB-50M,SC-51M,SD-51M,SE-51M,SF-51M,SG-51M,SM-51M,SN-51M	36206	36207
Set #4M	6	12	SA-1M,SA-14M,SC-14M,SC-1M,SD-14M,SD-1M,SE-1M,SF-1M,SG-1M,SM-2M,SN-1M	36213	36214
Set #5M	6	8	SA-1M,SC-1M,SD-1M,SE-1M,SF-1M,SG-1M,SL-1M,SM-2M	36209	36215
Set #6M	6	8	SA-5M,SC-3M,SC-5M,SD-5M,SF-3M,SF-5M,SG-3M,SL-4M	36208	36210
Set #7M	6	9	SA-1M,SA-3M,SA-5M,SC-1M,SC-3M,SC-5M,SF-1M,SF-3M,SF-5M	36218	36219
Set #9M	3	9	SA-43M,SC-42M,SD-42M,SE-41M,SF-42M,SH-41M,SL-42M,SM-43M,SN-42M	36223	36224

## Bur Sets - Inch

Tool Code	Shank Dia d2	No. of Pieces	Bur Set Contents	Standard Cut	Double Cut
Set #1	1/8	12	SA-42, SA-43, SC-41, SC-42, SD-42, SE-41, SF-42, SG-44, SH-41, SL-42, SM-43, SN-42	36196	36197
Set #2	1/8	9	SA-51, SA-50, SC-51, SD-51, SE-51, SF-51, SG-51, SM-51, SN-51	36201	36202
Set #4	1/4	12	SA-1, SA-14, SC-14, SC-1, SD-14, SD-1, SE-1, SF-1, SG-1, SM-2, SN-1	36211	36212
Set #5	1/4	8	SA-1, SC-1, SD-1, SE-1, SF-1, SG-1, SL-1, SM-2	36225	36226
Set #6	1/4	8	SA-5, SC-3, SC-5, SD-5, SF-3, SF-5, SG-3, SL-4	36227	36228
Set #7	1/4	9	SA-1, SA-3, SA-5, SC-1, SC-3, SC-5, SF-1, SF-3, SF-5	36216	36217
Set #9	1/8	9	SA-43, SC-42, SD-42, SE-41, SF-42, SH-41, SL-42, SM-43, SN-42	36221	36222

# PDT10

## Piloted Die Trimmer

For die repair using hand-held grinders. Double Cut style only.

- Smooths out and blends the weld or filler metal used when repairing dies.
- The Double Cut style offers a great combination of high material removal and a good finish.
- The pilot on the die trimmer stabilizes the router and the die grinder, allowing for more accurate shaping and finishing of repair spots.
- The pilot keeps the tool from scoring the surface of the die during use. It prevents the tool's cutting edges from making contact with the die surface – cutting only the filler material.
- Double Cut available from stock. Other cut styles available upon request.

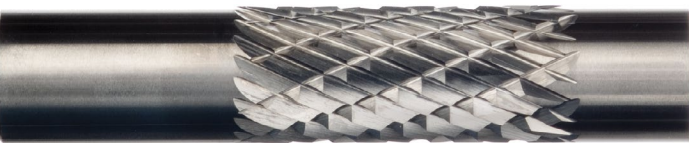

PDT10

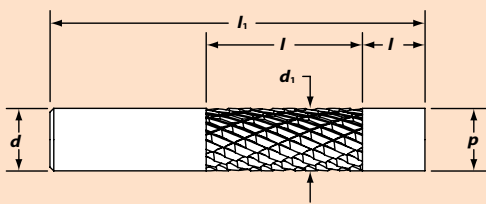

in  $d_1 + 0 / -.005$   $d_2 + 0 / -.0005$   $p + 0 / -.0005$

## PDT10 - Inch

Cutter Dia d1	Pilot Dia p	Shank Dia d2	Length of Cut l2	Pilot Length l1	Overall Length l1	EDP Number
1/8	1/8	1/8	1	1/2	2-1/2	05634
3/16	3/16	3/16	1	1/2	2-1/2	05647
1/4	1/4	1/4	1	1/2	2-1/2	05630
3/8	3/8	3/8	1	1/2	2-1/2	05643
1/2	1/2	1/2	1	1/2	2-1/2	05640

## DIE TRIMMER VARIATIONS

IMCO recognizes that all dies and their applications are unique – so they require unique tools to repair them and extend their life.

Many variations of the die trimmer are possible. Custom lengths, tool diameters, cut styles, and pilot dimensions are readily available. Contact IMCO for quotations or advice for tooling for your specific application.

# ROUTERS

## FR10 Fiberglass Router Features

Diamond Cut pattern allows for more aggressive material removal than Double Cut routers.

The up-cut geometry of the FR10 router pulls the work piece tightly against the template for clean, smooth cuts. *Allows for the routing of stacked parts.*

## DID YOU KNOW?

IMCO routers are often used by companies in these industries:

- Aerospace
- Recreational vehicles
- Trucking
- Pickup cabs manufacturing
- Watercraft manufacturing and repair
- Snowcraft manufacturing and repair



The FR10 is available with a variety of **end-cut options:**



### Plain End

**Plain end** – Also called “safe end” tools. Use for edge routing or when the end of the router will not come in contact with the work piece.

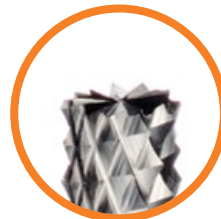

### Bur End Cut

**Bur end cut** – Use for bottom cutting to leave a smooth, even surface with a square corner.

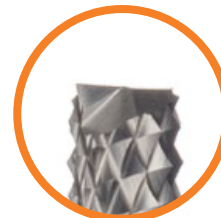

### End Mill End Cut

**End mill end cut** – Use for bottom cutting for a smooth bottom surface with a square corner.

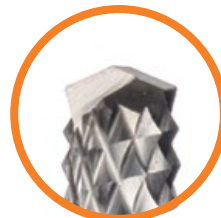

### Drill Point End Cut

**135° drill point end** – Use before the routing operation to plunge through the work piece. **NOTE:** Take special care while plunging that the router end does not come in contact with the work-holding apparatus.

# FR10

## FR10 Fiberglass Routers

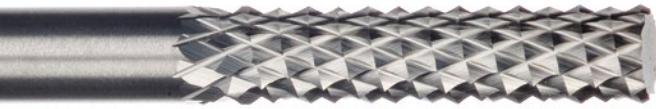

FR10

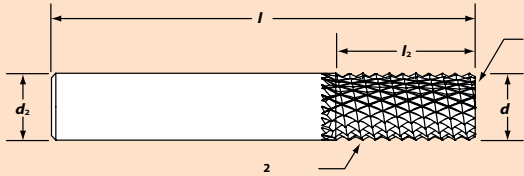

in  $d_1 +0/-0.005$   $d_2 +0/-0.0005$       mm  $d_1 +0/-0,127$   $d_2 +0/-0,0127$

### FR10 - Metric

Tool Code	Cutter Dia d1	Shank Dia d2	Length of Cut l2	Overall Length l1	Plain End	Bur End	End Mill End	Drill Point End
MFR-2	3	3	12	38	36615	36616	36617	36618
MFR-3	4	4	16	50	36625	36626	36627	36628
MFR-6	6	6	25	63	36655	36656	36657	36658
MFR-6-1	6	6	25	76	36675	36676	36677	36678
MFR-7	8	8	25	63	36685	36686	36687	36688
MFR-8	10	10	25	70	36695	36696	36697	36698
MFR-9	12	12	25	76	36705	36706	36707	36708

### FR10 - Inch

Tool Code	Cutter Dia d1	Shank Dia d2	Length of Cut l2	Overall Length l1	Plain End	Bur End	End Mill End	Drill Point End
FR-2	1/8	1/8	1/2	1-1/2	36621	36622	36623	36624
FR-3	3/16	3/16	5/8	2	36631	36632	36633	36634
FR-5	1/4	1/4	3/4	2	36641	36642	36643	36644
FR-6	1/4	1/4	1	2-1/2	36651	36652	36653	36654
FR-6-1	1/4	1/4	1	3	36661	36662	36663	36664
FR-7	5/16	5/16	1	2-1/2	36671	36672	36673	36674
FR-8	3/8	3/8	1	2-1/2	36681	36682	36683	36684
FR-9	1/2	1/2	1	3	36701	36702	36703	36704

### Router Application Guide • Speed & Feed

Tool Dia. Metric	Speed (MPM)		Feed Rate IPR
	Min.	Max	
2	183	274	.051
3	183	274	.051
4	183	274	.051
6	183	274	.051
8	183	274	.051
10	183	274	.051
12	183	274	.051

**Cut time on the job with time-tested tools from IMCO.**

See a video of these IMCO tools in action at:

**[www.imcousa.com/tools/burs](http://www.imcousa.com/tools/burs)**

Test them for yourself with a free tool test. To order, or for more information:

In USA call **1-800-765-4626**

International **419-661-6313**

Fax **419-661-6314**



Visit **[www.imcousa.com](http://www.imcousa.com)**  
by scanning this code with a  
QR code reader.



**Power. Precision. Performance.**

ISO 9001:2000 Registered

(Made in U.S.A.)

©2011 IMCO Carbide Tool Inc.